

Assembly Instructions Model 6XX

The following instructions are to complete the assembly of your Manco Fun Kart using the component parts and hardware that were packaged with the kart. Carefully read these instructions completely before starting the assembly.

Tools required for assembly

- (2) 9/16 inch wrenches
- (2) 3/4 inch wrenches
- (2) 7/16 inch wrenches
- (1) 3/8 inch wrench

 **Warning: Risk of death or Bodily Injury.** The Brush Bars, and the Seat and Shoulder Belt are critical parts of the Operator / Passenger safety system on this kart. Do not attempt to operate the kart until these components have been properly installed.

Brush Bar Assembly

Position the rear bar assembly on the frame using four 3/8 x 16 x 3.5 inch long bolts (PN 2386) and 3/8 inch nuts (PN 9085) to hold it in place. Do not tighten these fasteners completely at this time.

Position the over head bar assembly on the kart using four 3/8 x 16 x 3.5 inch long bolts (PN 2386) and 3/8 inch nuts (PN 9085).

Fully tighten all of the brush bar and headrest mounting bolts at this time. These fasteners use locking nuts and require a high level of

torque to be applied to tighten them securely.

Make sure that the nuts and heads of the bolts are fully engaged with the surface of the bushings. Then apply a final tightening torque.

Seat and Headrest Pad Assembly

Assemble the rear pad of the seat to the seat frame using two 1/4 x 20 x 5/8 inch long bolts (PN 1876).

Assemble the head rests to the support bar using four 1/4 x 20 x 5/8 inch long bolts (PN 1876). Tighten these fasteners securely at this time.

Shoulder Belt Assembly

Position the shoulder belt mounting tab against the support tab on the rear bar assembly with a 1/2 washer (PN 9022) between the tabs. Use a 1/2 x 13 x 1.5 inch long bolt (PN 9188) and 1/2 inch nut (PN 1012) to secure these two tabs together. Tighten the bolt and nut until the two tabs make contact with the washer between them but do not over tighten. When properly assembled, the belt tab should be able to rotate freely on the mounting bolt.

Follow this process for both the Operator and Passenger belts.

Safety Flag Assembly

Insert the special flag mounting bolt (PN 11361) into the mounting tab on the rear loop of the frame placing a 1/2 inch washer (PN 9022) under

the head of the bolt. Place a 1/2 inch nut (PN1012) on the end of the bolt and hand tighten. Insert the flag mounting shaft through the mounting bolt allowing approximately 1/2 inch of the shaft to protrude past the end of the bolt. Use wrenches to securely tighten the nut and bolt to fix the position of the flag

Engine Fluids

Read and follow instructions in the engine manual.

Remove oil fill plug and fill the engine crankcase with 20 oz of 30W type SF or higher motor oil. Replace and securely tighten the oil fill plug.

Fill the fuel tank with regular grade clean, unleaded gasoline. Do not use premium grade gasoline, gasohol or diesel fuel.

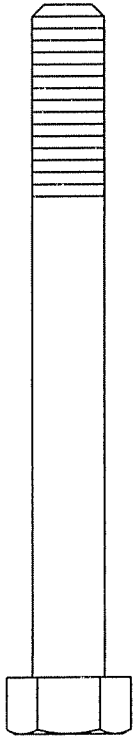
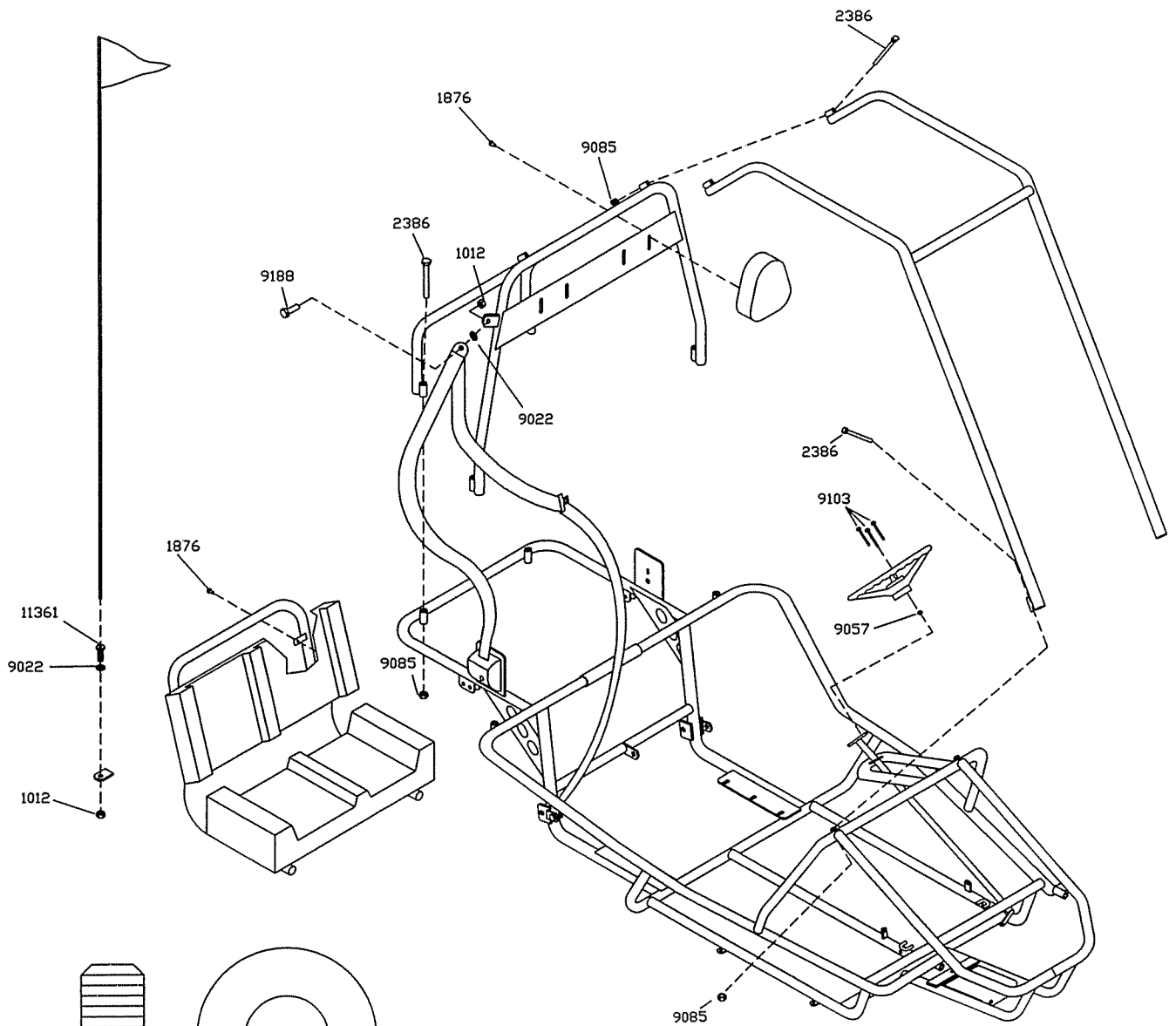

2386
QTY (8)
3/8-16
X 3.500

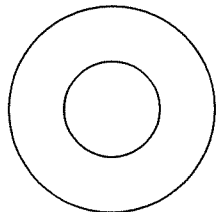

9022
QTY (3)

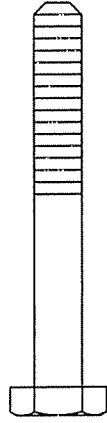

9103
QTY (3)
1/4-20
X 2.00

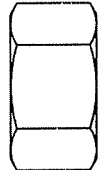

1012
QTY (3)

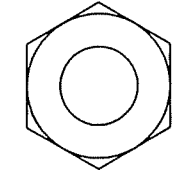

9085
QTY (8)

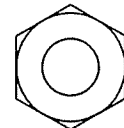

9057
QTY (3)

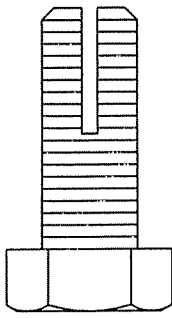

11361
QTY (1)
FLAG BOLT

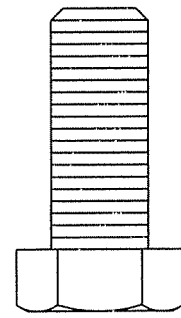

9188
QTY (2)
1/2-13 X 1.50

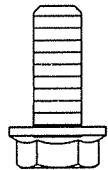

1876
QTY (6)
1/4-20 X .625